

アルミルーバー YL-4010-K  
開口率=48.8%

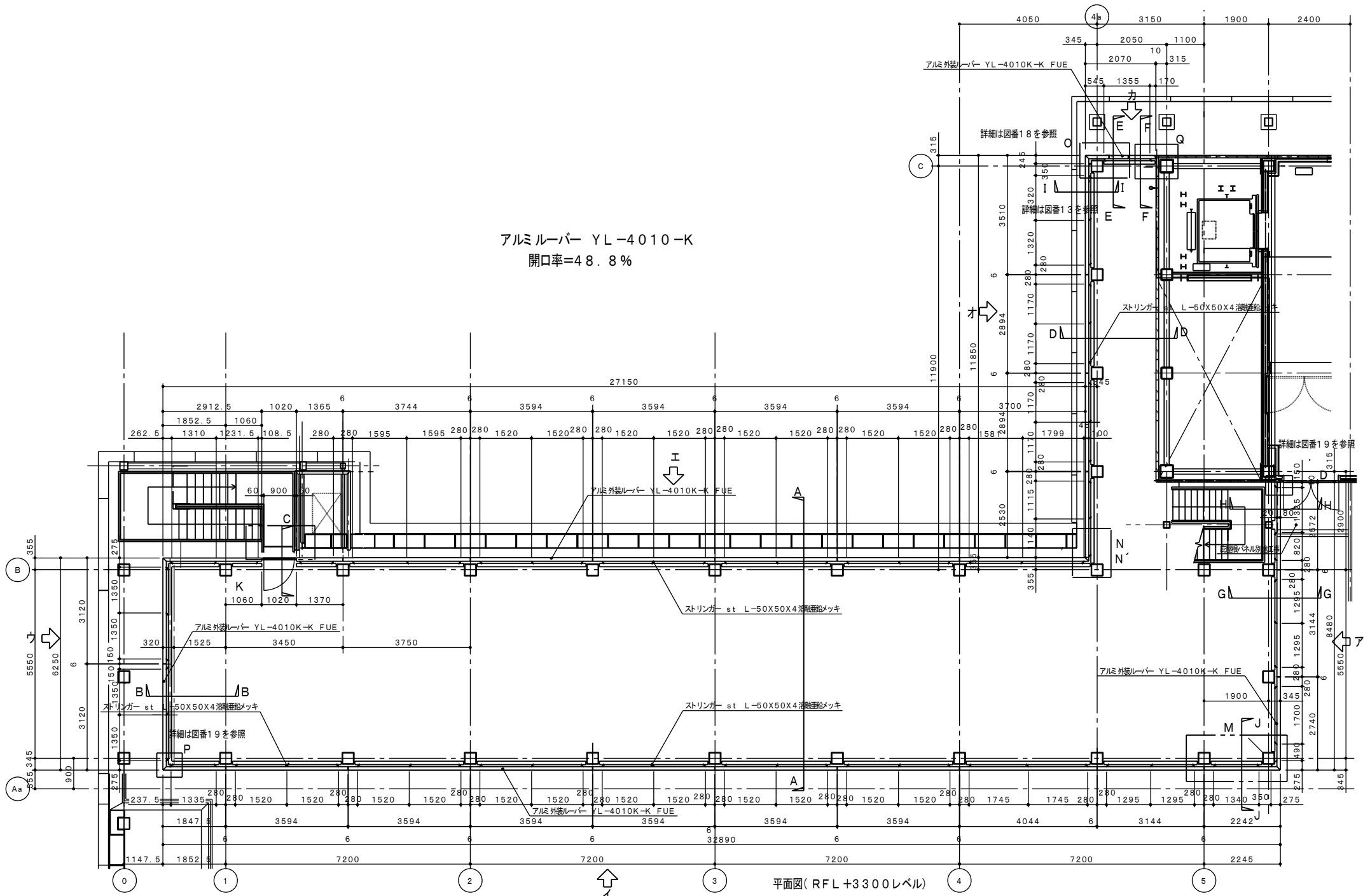

平面図 (RFL+3300レベル)

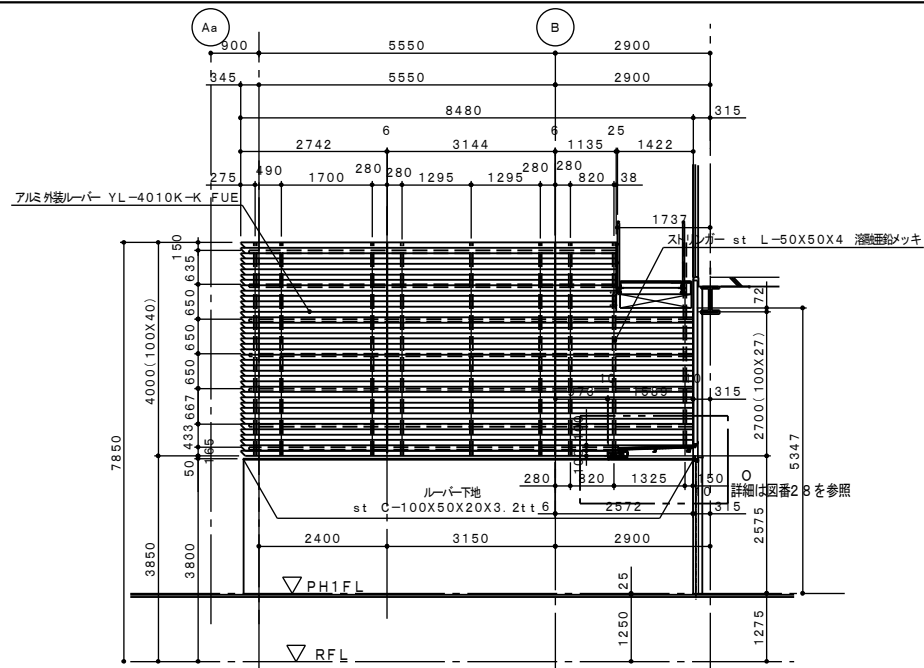

ア矢視 外装ルーバー姿図 S: 1/50

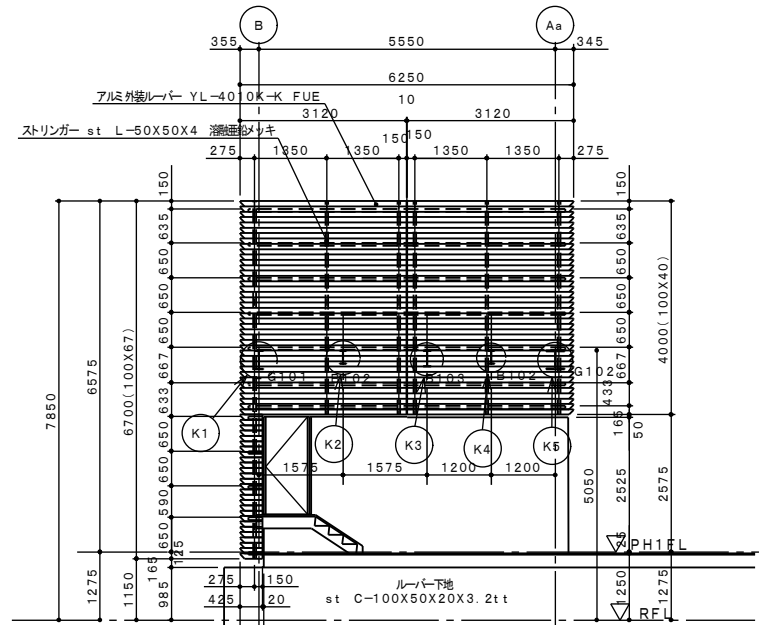

バ矢視 外装ルーバー姿図 S: 1/50

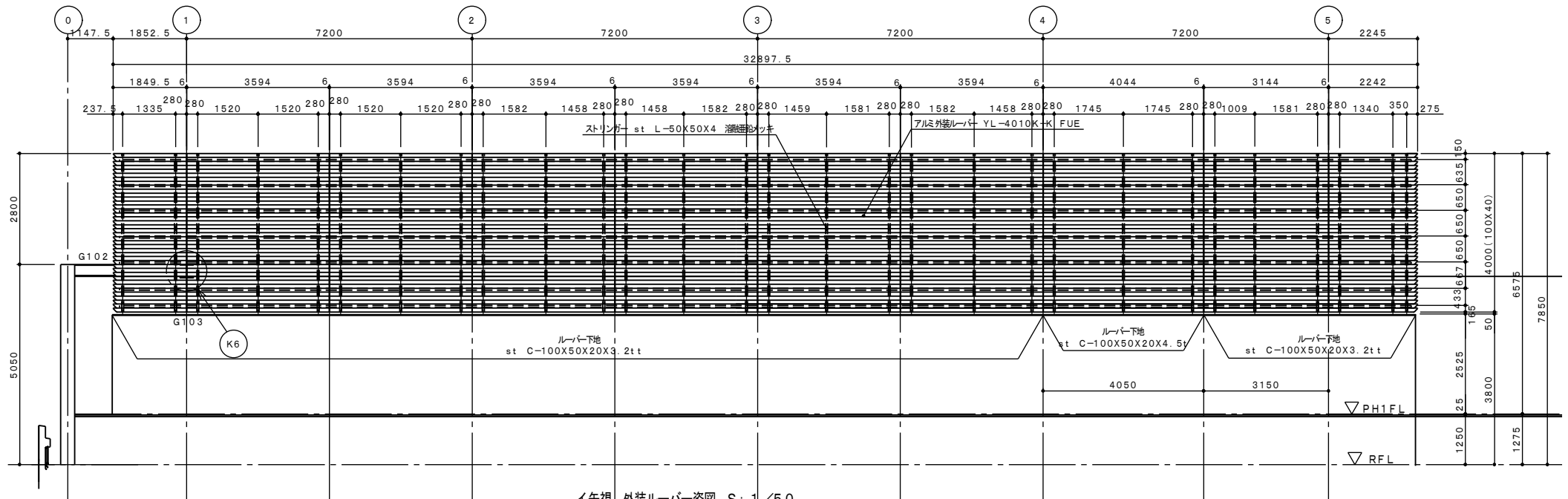

イ矢視 外装ルーバー姿図 S: 1/50

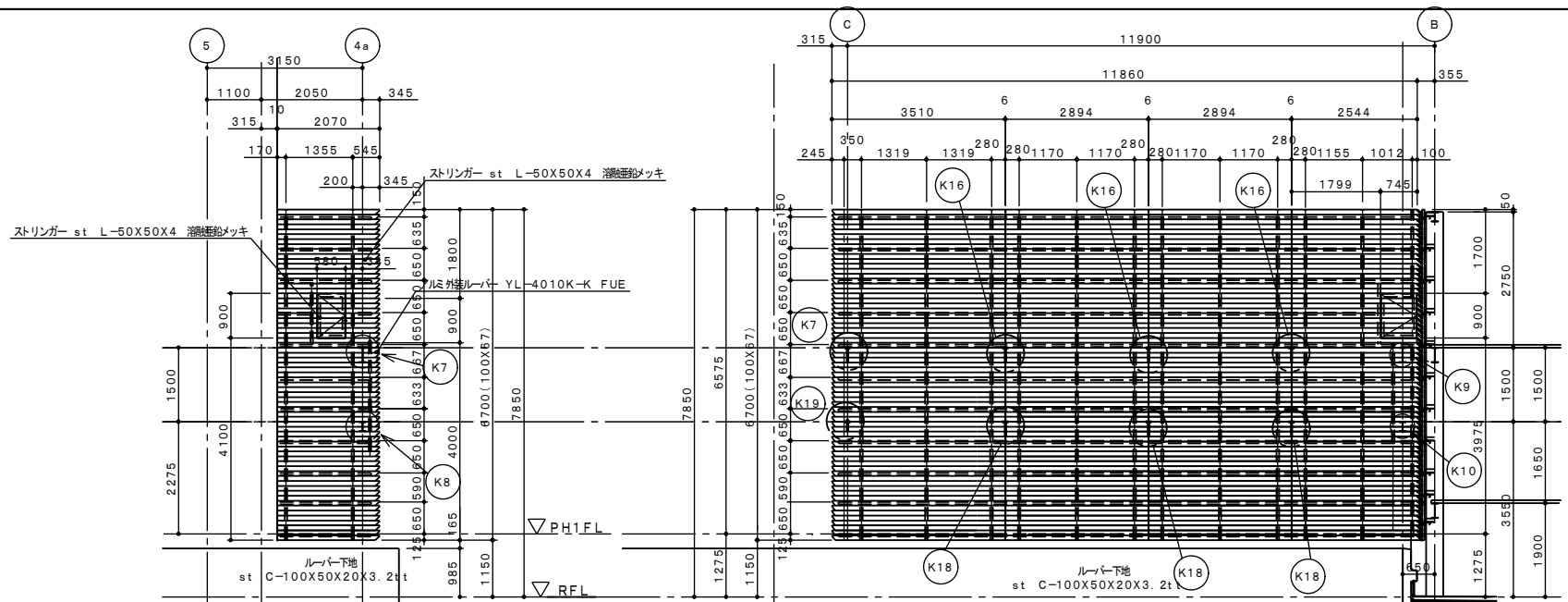

カ矢視 外装ルーバー姿図 S: 1/50

オ矢視 外装ルーバー姿図 S: 1/50

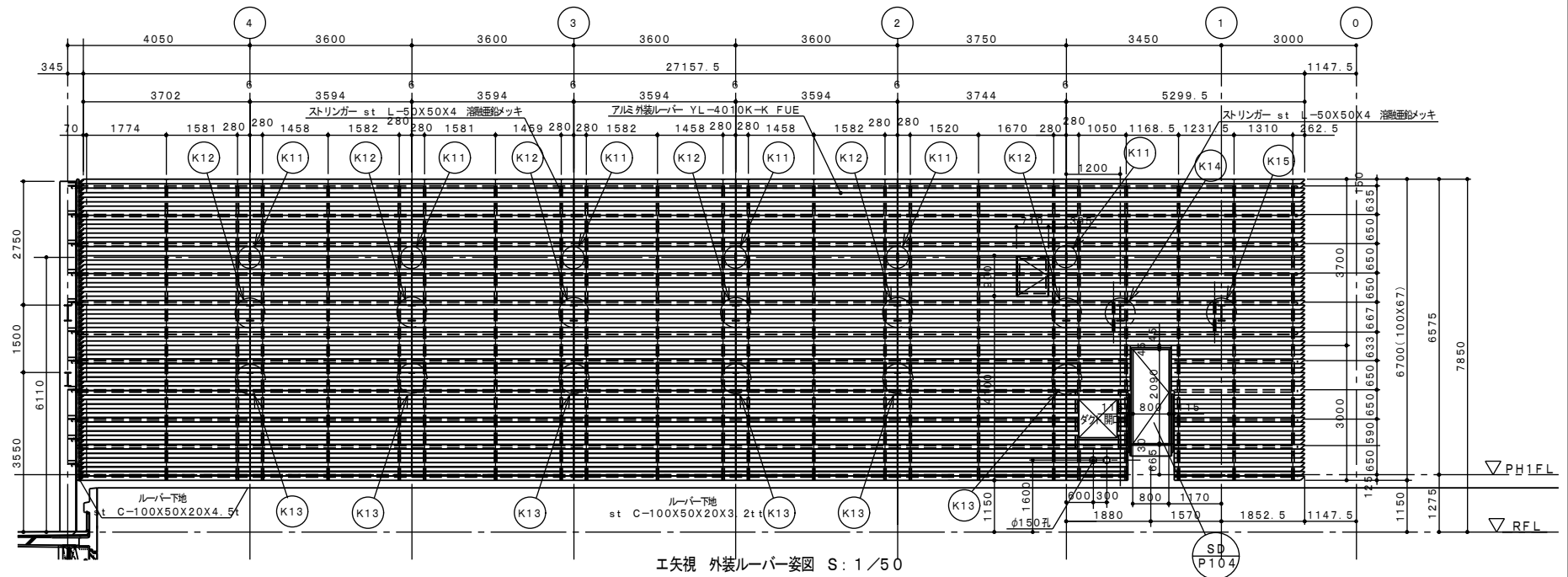

エ矢視 外装ルーバー姿図 S: 1/50

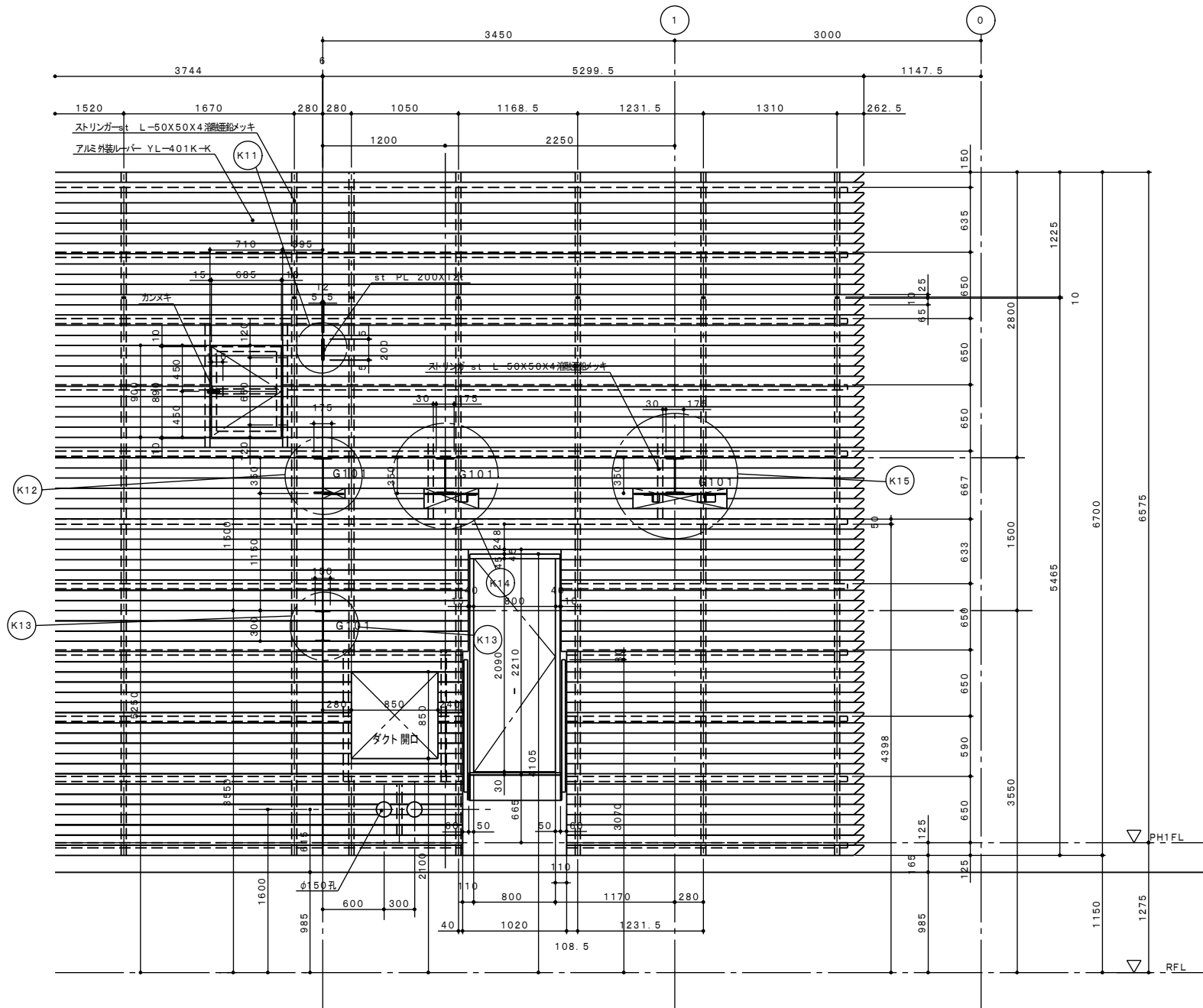

工矢視図部分姿図詳細図 S: 1 / 20

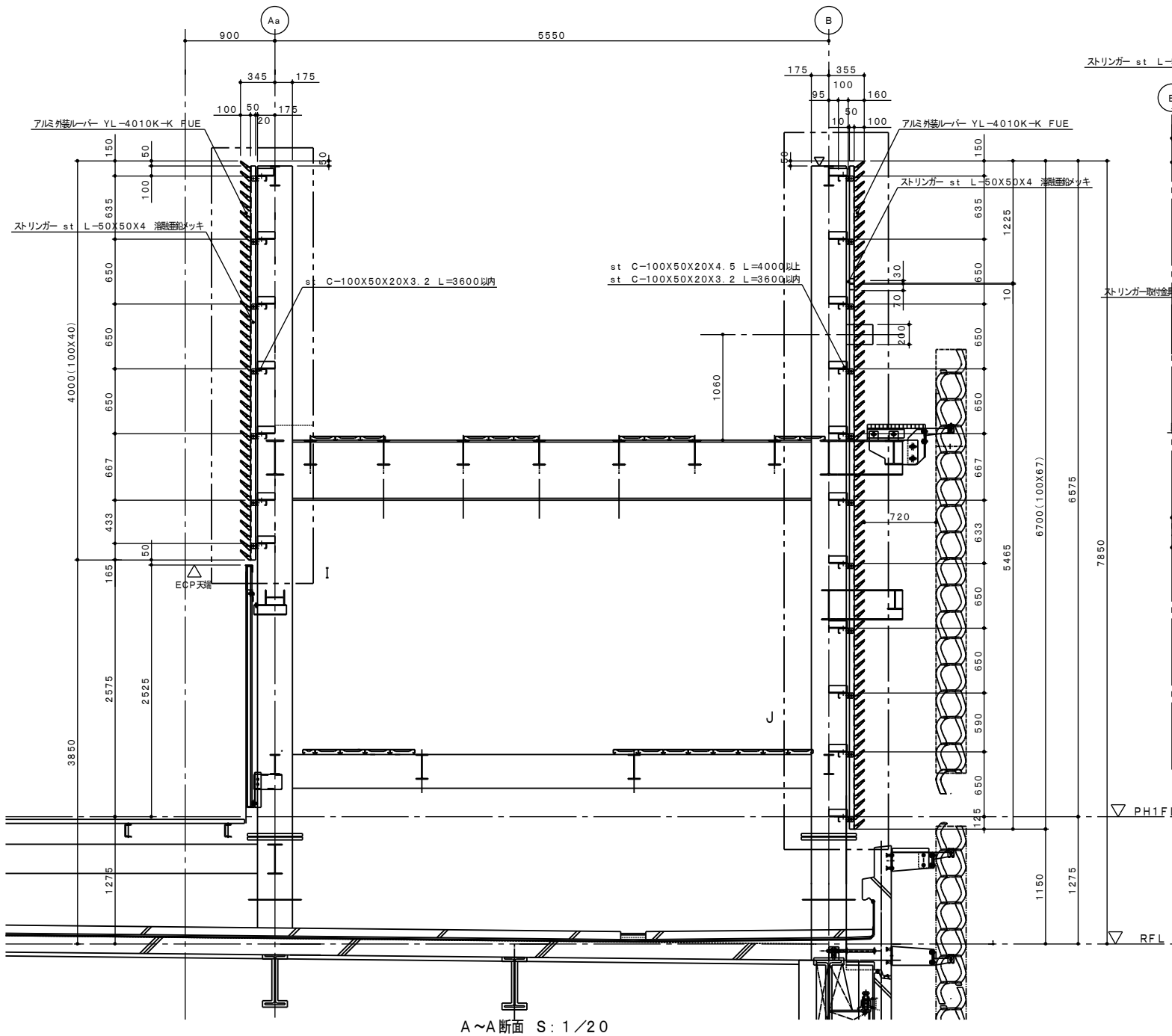

A~A断面 S: 1/20

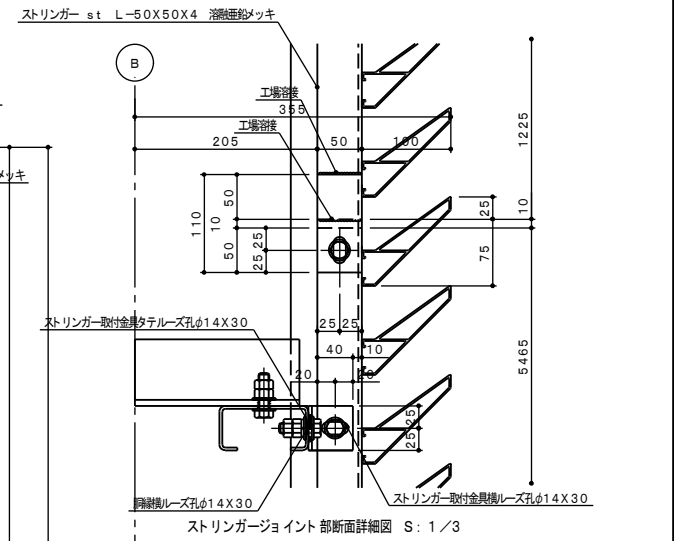

ストリンガージョイント部断面詳細図 S: 1/3

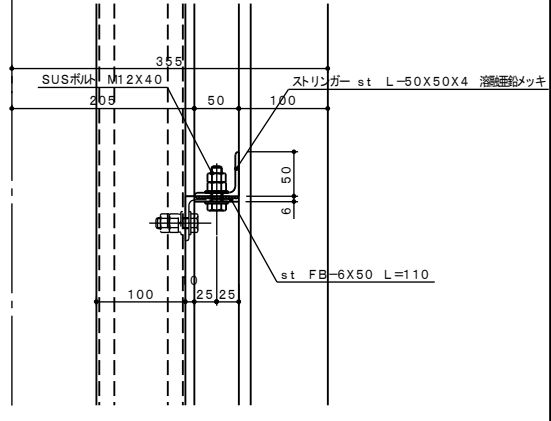

ストリンガージョイント部断面詳細図 S: 1/3

▽ PH1FL.

▽ RFL.



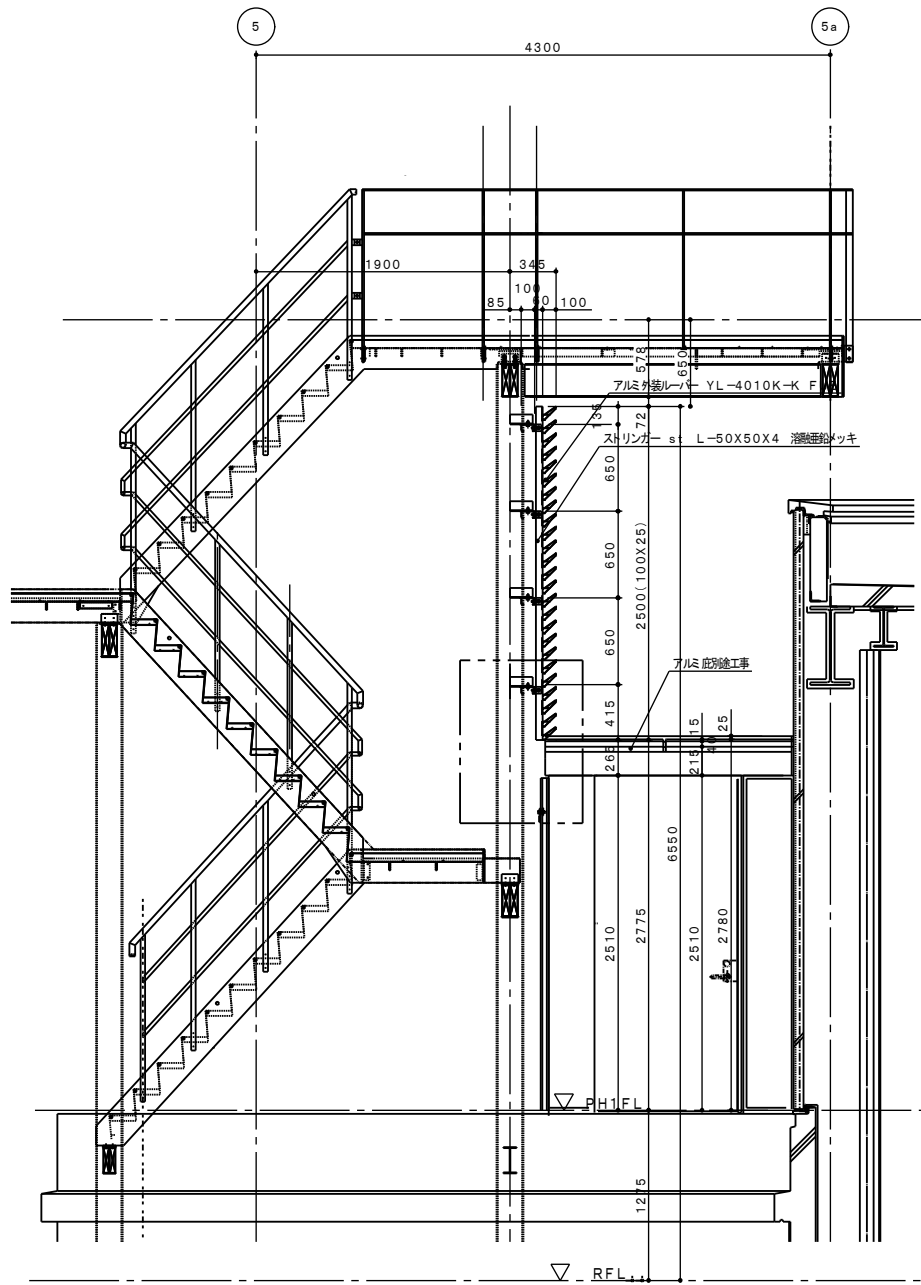

H~H断面 S: 1/20

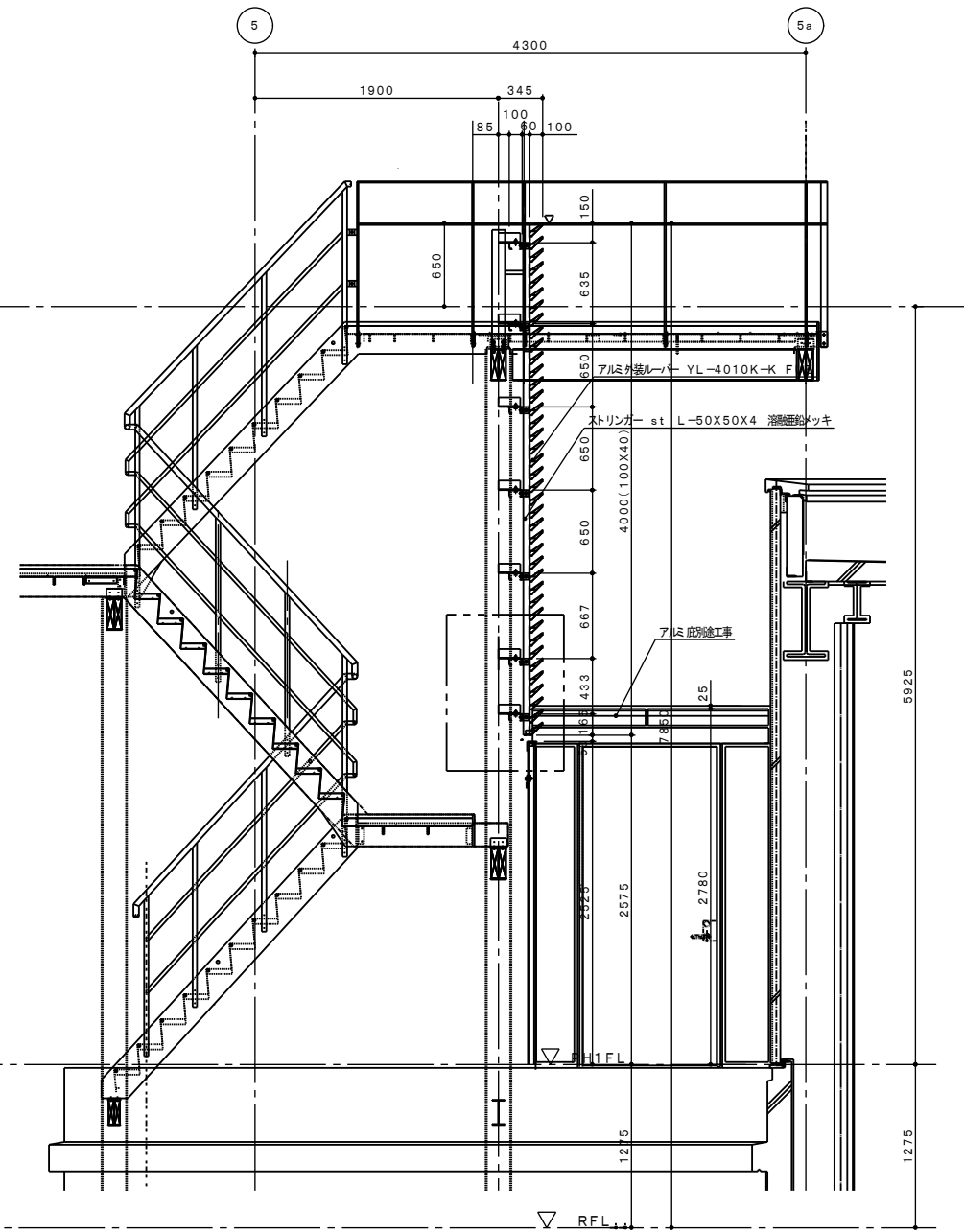

G~G断面 S: 1/20

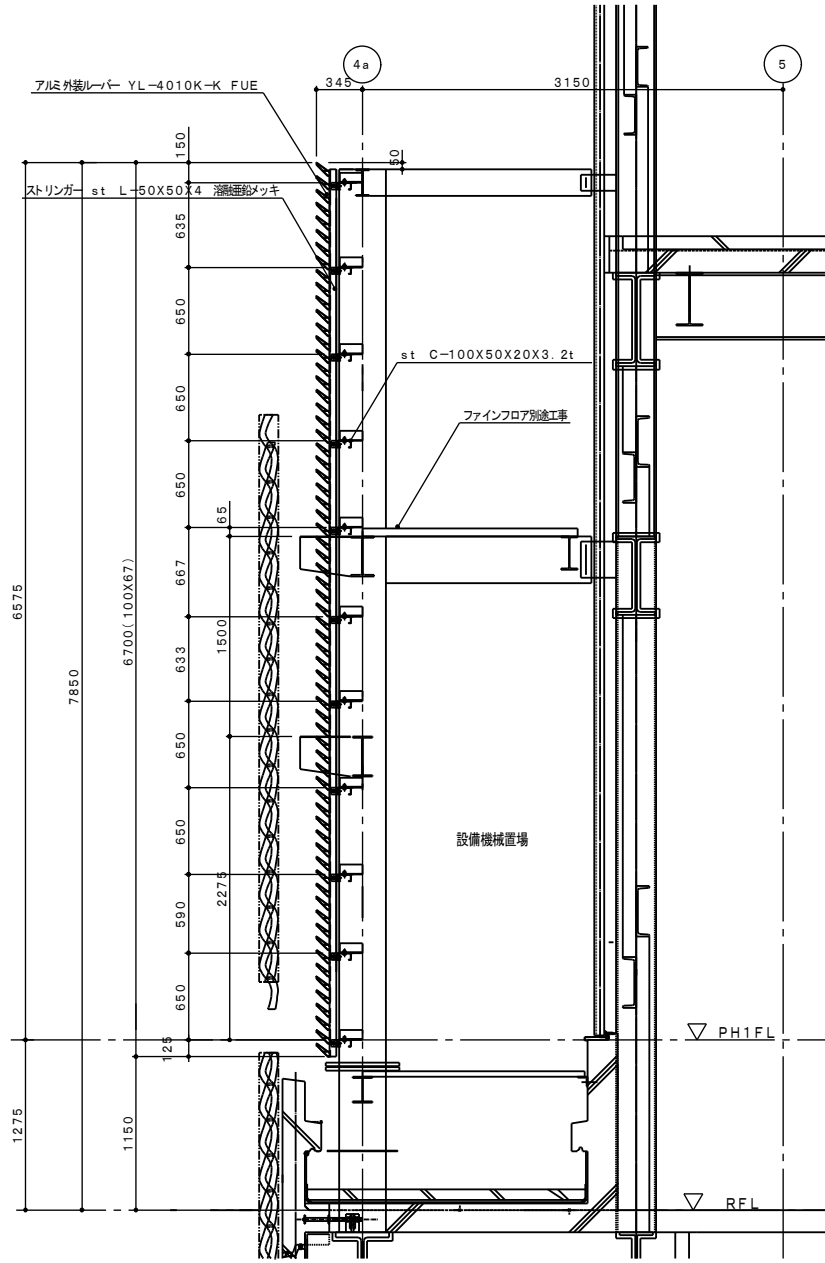

D~D断面 S: 1/20

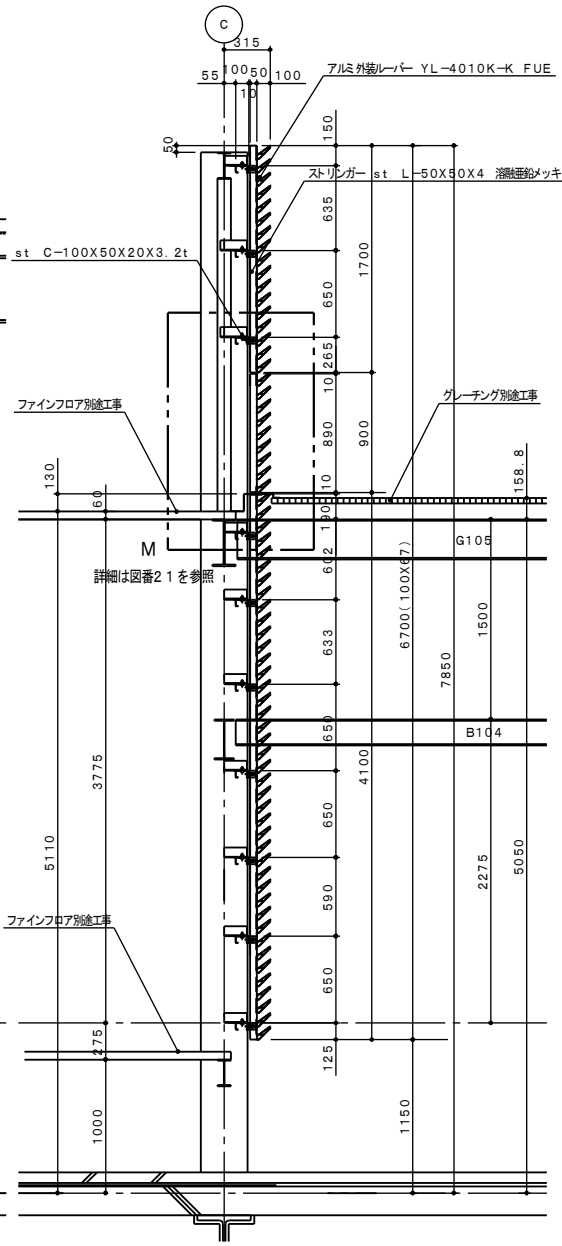

E~E断面 S: 1/20

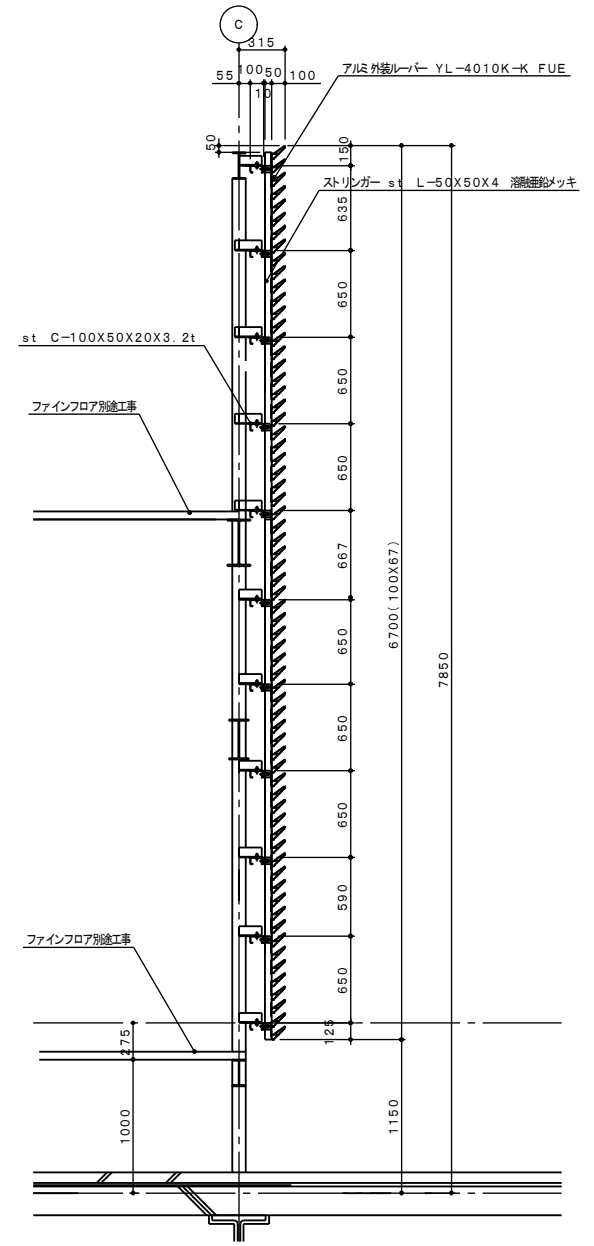

F~F断面 S: 1/20



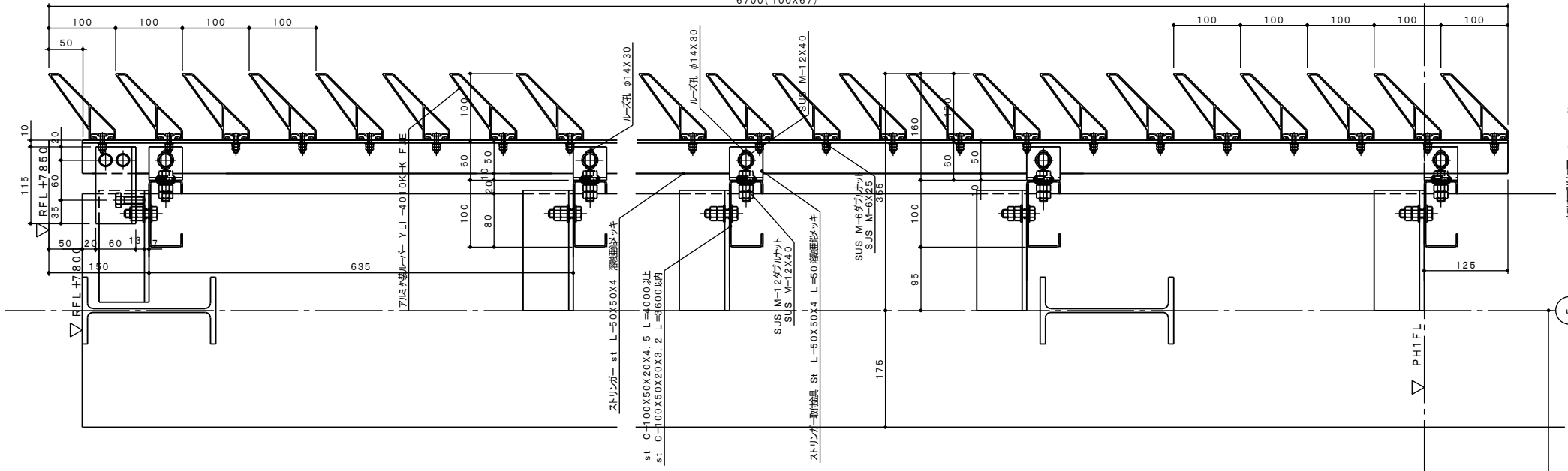

J 窓面詳細図 S:1/3

6

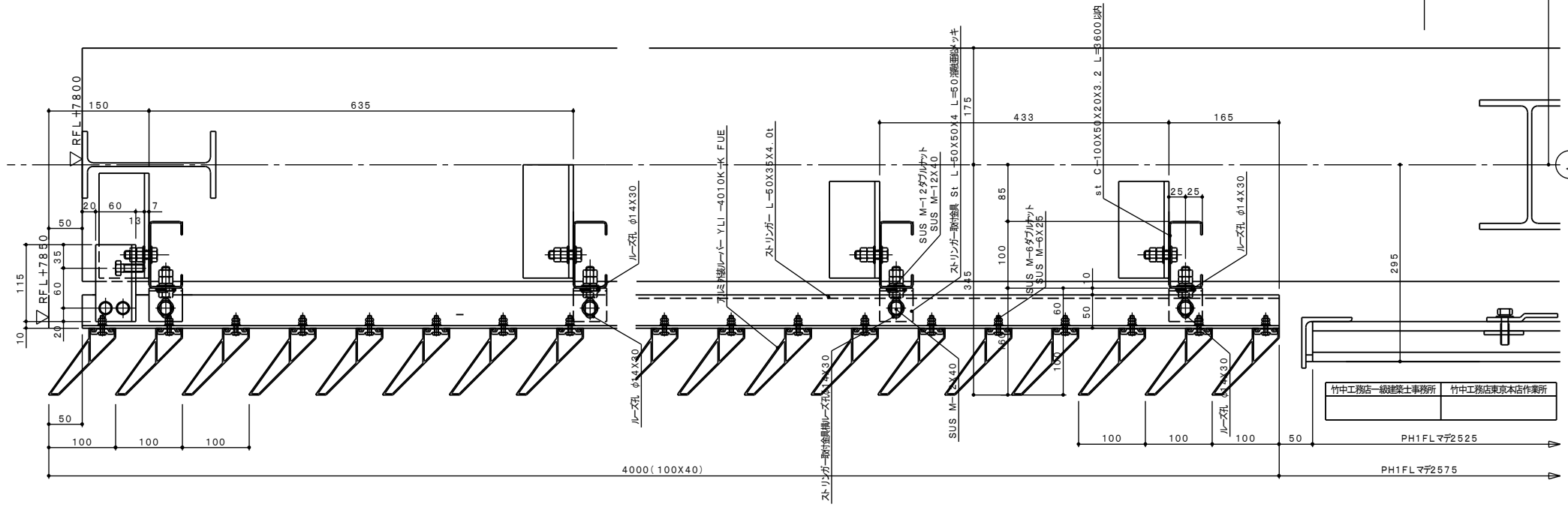

I 窓面詳細図 S:1/3

Aa

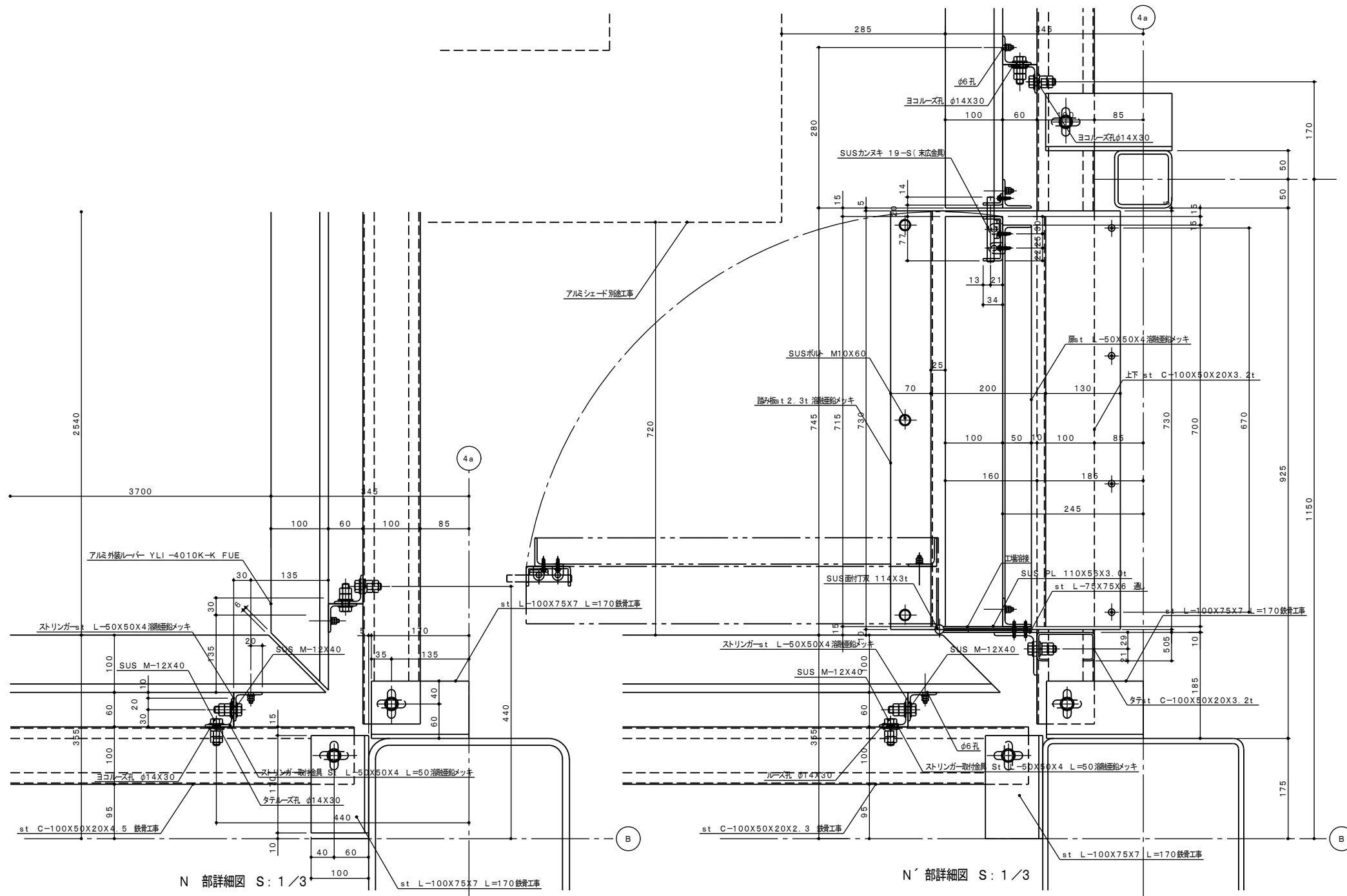

N 部詳細図 S: 1/3

N' 部詳細図 S: 1/3



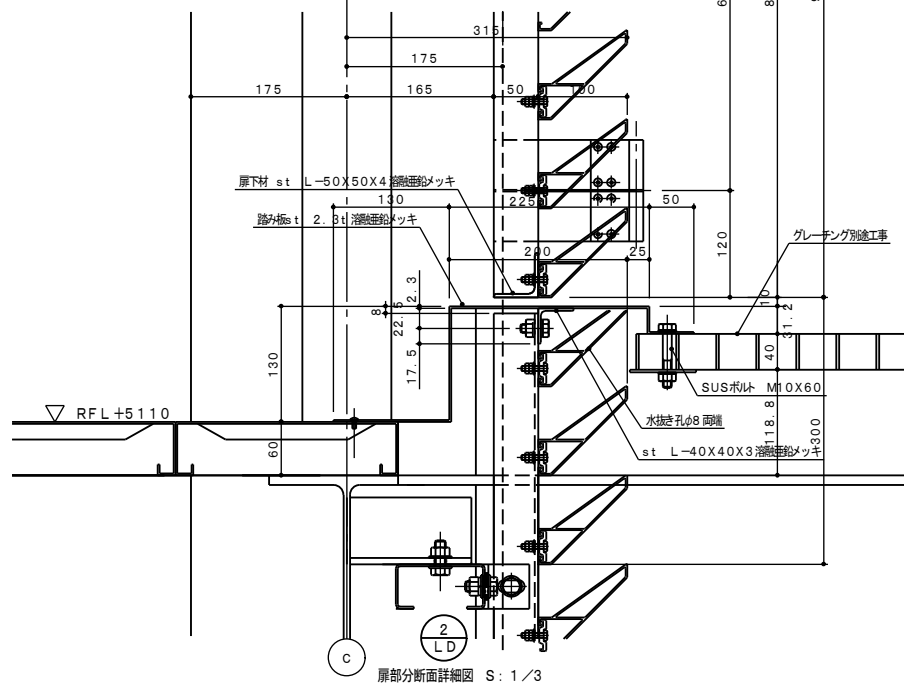
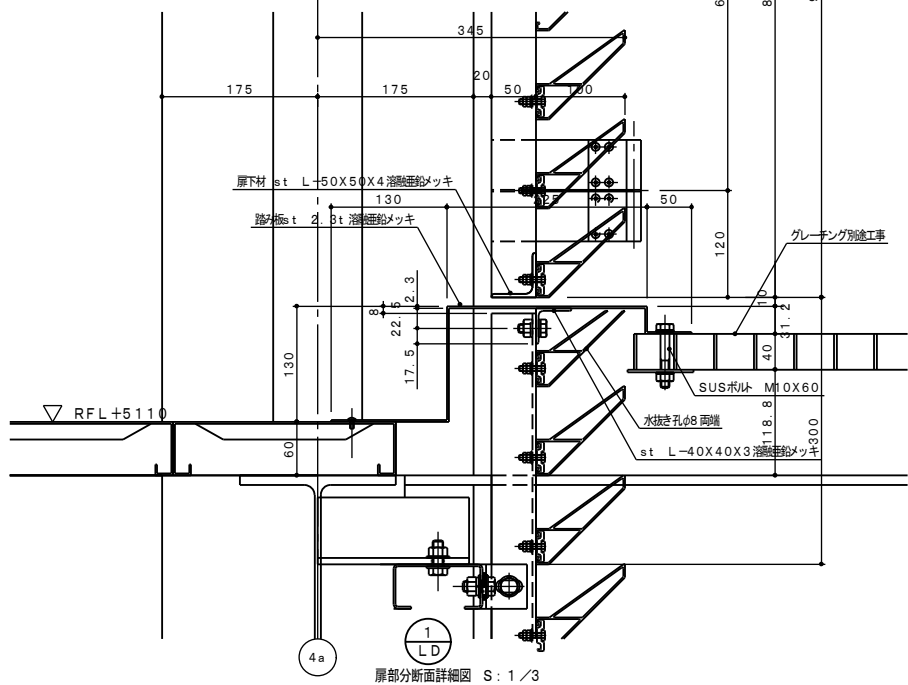
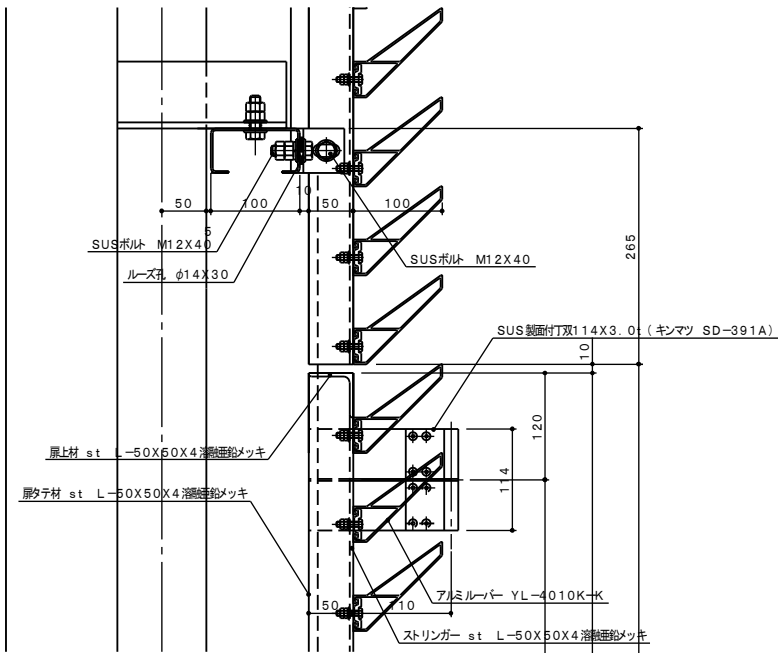
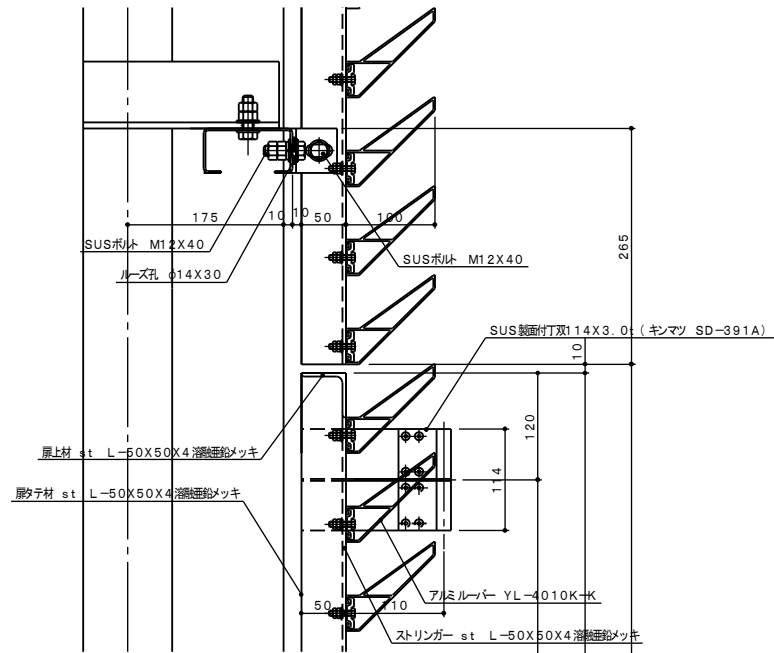

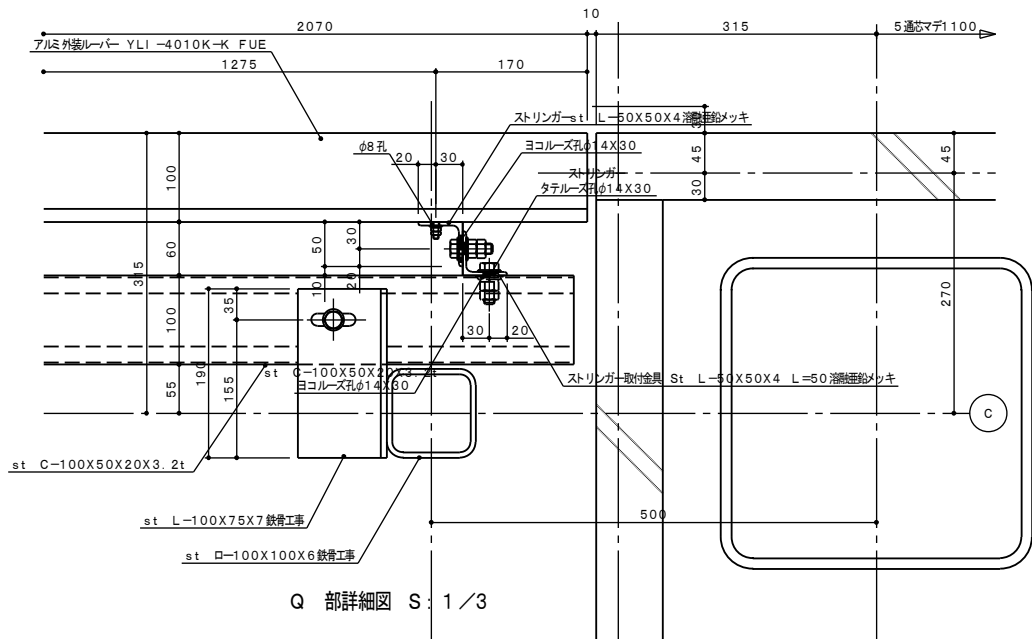

Q 部詳細図 S: 1/3

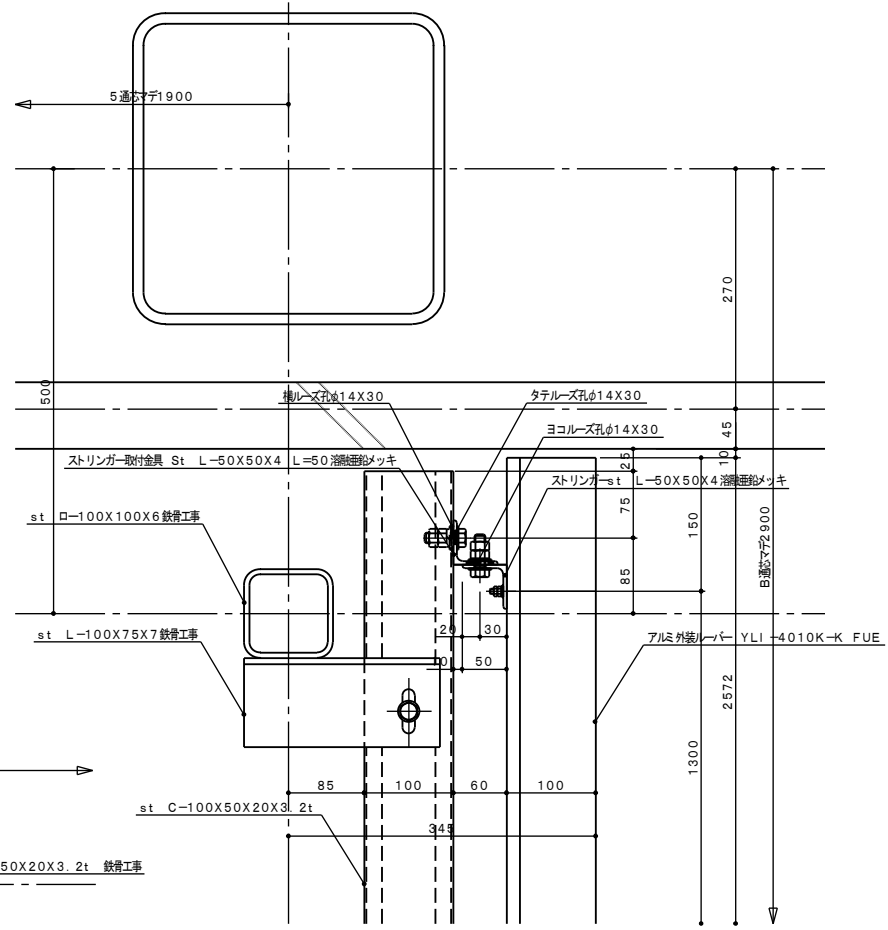

R 部詳細図 S: 1/3

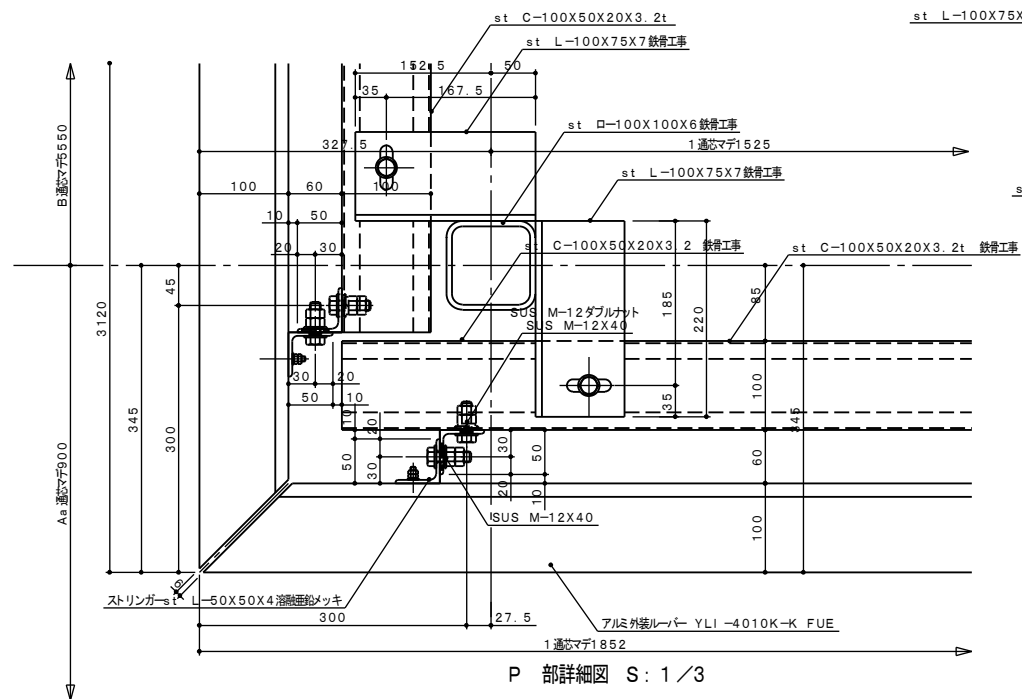

P 部詳細図 S: 1/3